

Linear system **DSZ 120, 160, 200**



BELT DRIVE

↔ UNIVERSAL SYSTEM

🔧 LONG TRAVERSE PATH > 6000 MM

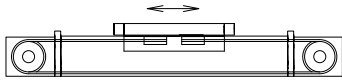

Function:

This unit consists of a rectangular aluminium profile with 2 integrated rail guides. The carriage is moved by a belt drive. Each standard pulley has got one coupling claw on one side. Belt tension can be readjusted by a simple screw adjustment device in the carriage. This device can also be used for symmetrical adjustment of two or more linear units running parallel. The openings of the guide body are sealed with 3 stainless steel cover bands to protect the guide from splash water and dust. Alternatively, it can also be supplied without cover bands. With this series, multi-part assembled units with long strokes can be realized.

Fitting position:

As required. Max. length 6.000 mm without joints.

Carriage mounting:

By T-slots.

Unit mounting:

By T-slots and mounting sets. The linear axis can be combined with any T-slot profile.

Belt type:

HTD with steel reinforcement, no backlash when changing direction, repeatability ± 0,1 mm.

Carriage support:

In the standard version, the carriage runs on 4 runner blocks which can be serviced at a central servicing position. For longer carriages the number of runner blocks can be increased.

Forces and torques	Size	120		160		200	
	permitted dyn. Forces*	5000 km	10000 km	5000 km	10000 km	5000 km	10000 km
F_x (N)		894	800	1900	1800	4000	3800
F_y (N)		1776	1405	5570	3900	15600	11080
F_z (N)		2090	1650	7050	5020	20600	14600
M_x (Nm)		81	64	358	255	1285	915
M_y (Nm)		97	77	369	262	1375	980
M_z (Nm)		96	76	364	258	1345	960
All forces and torques related to the following:							
existing values $\frac{F_y}{F_{y_{dyn}}} + \frac{F_z}{F_{z_{dyn}}} + \frac{M_x}{M_{x_{dyn}}} + \frac{M_y}{M_{y_{dyn}}} + \frac{M_z}{M_{z_{dyn}}} \leq 1$							
table values $\frac{F_y}{F_{y_{dyn}}} + \frac{F_z}{F_{z_{dyn}}} + \frac{M_x}{M_{x_{dyn}}} + \frac{M_y}{M_{y_{dyn}}} + \frac{M_z}{M_{z_{dyn}}} \leq 1$							
No-load torque							
Nm without cover bands		1,2		1,5		2,0	
Nm with cover bands		1,6		2,1		4	
Speed							
(m/s) max		5		5		5	
Tensile force							
permanent (N)		900		1900		4000	
0,2 s (N)		1000		2090		4300	
Geometrical moments of inertia of aluminium profile							
I_y mm ⁴		5,61x10 ⁵		2,13x10 ⁶		4,81 x10 ⁶	
I_z mm ⁴		34,19x10 ⁵		12,33x10 ⁶		26,0 x10 ⁶	
Elastic modulus N/mm ²		70000		70000		70000	

* referred to life-time

Driving torque:

$$M_o = \frac{F \cdot P \cdot S_i}{2000 \cdot \pi} + M_n$$

$$P_o = \frac{M_o \cdot n}{9550}$$

F = force (N)
 P = pulley action perimeter (mm)
 Si = safety factor 1,2 ... 2
 Mn = no-load torque (Nm)
 n = rpm pulley (min⁻¹)
 Mo = driving torque (Nm)
 Po = motor power (KW)

Deflection:

$$f = \frac{F \cdot L^3}{E \cdot I \cdot 192}$$

f = deflection (mm)
 F = load (N)
 L = free length (mm)
 E = elastic modulus 70000 (N/mm²)
 I = second moment of area (mm⁴)

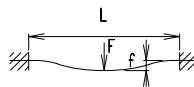

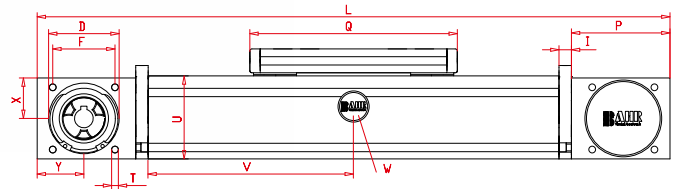
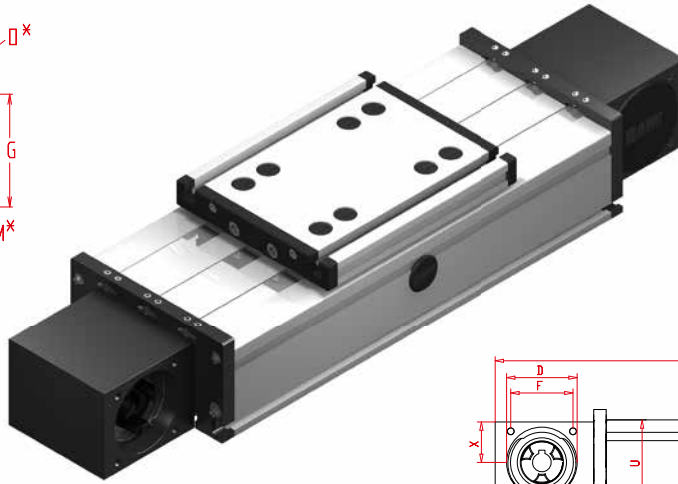
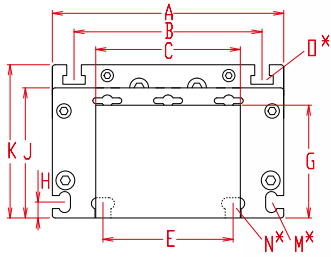

V = Q + 100 mm
W = servicing position

Increasing the carriage length will increase the basic length by the same amount.

Size	Basic length L	A	B	C	D -0,05	E	F	G	H	I	J	K	M for	N for	O for	P	Q	T	U	X	Y	Basic weight	Weight per 100 mm
DSZ 120	330	120	96	80	47	78	42	58	10	10	68	79	M 5	M 6	M 6	70	156	M 6	60	28	35	5,1 Kg	0,85 Kg
DSZ 160	440	160	130	100	68	90	60	78	11	12	90	106	M 6	M 8	M 8	95	200	M 8	80	39	45	12,0 kg	1,9 kg
DSZ 200	530	200	160	130	90	140	80	97	15	15	110	129	M 8	M 10	M 10	110	270	M 10	100	49	50	21,3 kg	2,9 kg

0 Choice of guide body profile: Stainless versions upon request.

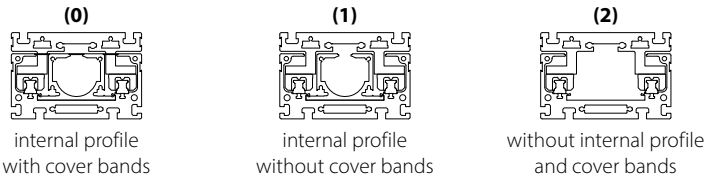

0 Choice of carriages:

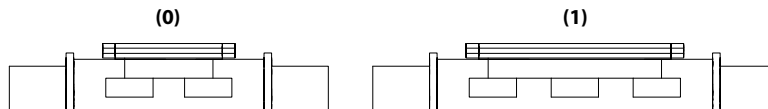

Size	Version 0		Version 1	
	Q	L	Q	L
120	156	330	156	330
160	200	440	>230	>470
200	270	530	>310	>570

0 Drive version:

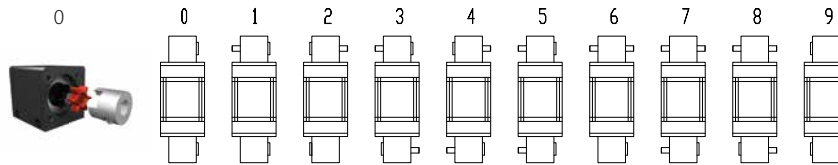

9 is as 0, but with coupling claws on both sides.
The standard version is supplied without shaft. A shaft can be retrofitted by inserting it into the pulley bore and securing it with 2 locking rings or tension sets (size 200).

Belt table:

Code No.	Size	Belt	mm/rev.	Number of teeth
0 4	120	5M25	130	26
0 7	160	8M30	176	22
0 9	160	8M50	176	22
0 9	200	8M50	224	28
1 0	200	8M70	224	28

Shaft dimensions / Coupling:

Size	Shaft ø h6 x length	Key	Coupling
120 (5M25)	14 x 35	5x5x28	14
160 (8M30)	18 x 45	6x6x40	19
160 (8M50)	25 x 35	8x7x32	----*
200 (8M50)	22 x 45	6x6x40	24
200 (8M70)	30 x 55	8x7x50	----*

* Coupling claw not possible with belt widening.

DSZ 160 1 0 0 0 0 7 1 1500 — Basic length + stroke = total length
Pos. 1 2 3 4 5 6 7

Sample ordering code:

DSZ160 with internal profile and cover bands, standard carriage, coupling claw on one side, 1060 mm stroke.