



SPINDLE DRIVE

-  INDEPENDENT INSTALLATION POSITION
-  PRECISION
-  UNIVERSAL SYSTEM

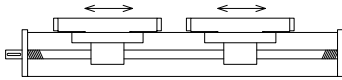
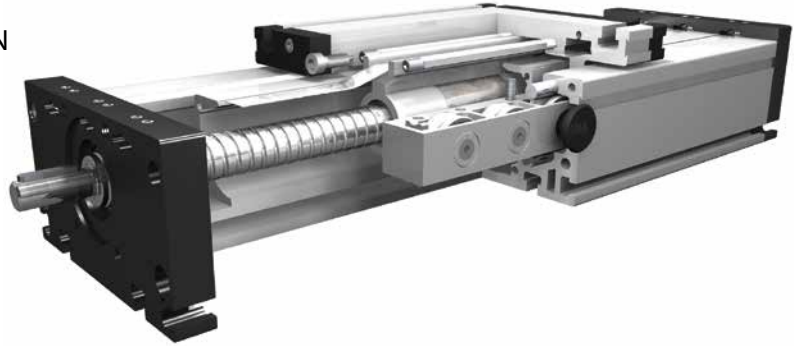

Function:

This unit consists of a rectangular aluminium profile with 2 integrated roller guides. The carriage is driven by means of a rotating spindle with leading nut. Where two parallel linear units are used or where two carriages are mounted on one unit, the leading-nut receiver can be used to adjust the symmetry of the carriages. The openings of the guide body are sealed with 3 stainless steel cover bands to protect the drive from splash water and dust.

Fitting position:

As required. Max. length 3.000 mm without joints.

Carriage mounting:

By T-slots.

Unit mounting:

By T-slots and mounting sets. The linear axis can be combined with any T-slot profile.

Carriage support:

In the standard version, the carriage runs on 8 rollers which can be adjusted and serviced at a central servicing position. For longer carriages the number of rollers can be increased. Repeatability ballscrew $\pm 0,025$ mm, trapezoidal thread $\pm 0,2$ mm.

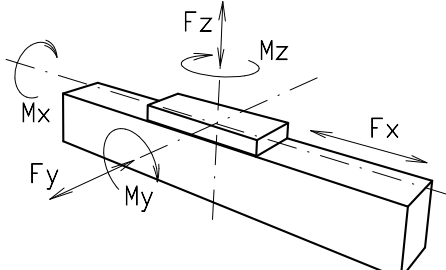
Forces and torques	Size	120		160		200	
	Forces/Torques	static	dynamic	static	dynamic	static	dynamic
	F_x (N)	900	800	5000	4000	10000	8000
	F_y (N)	1100	900	3000	2000	4400	3100
	F_z (N)	1250	1000	3500	2800	4900	4400
	M_x (Nm)	150	125	400	320	600	510
	M_y (Nm)	140	120	360	300	560	480
	M_z (Nm)	100	90	180	150	310	275
	All forces and torques related to the following: existing values $\frac{F_y}{F_{y_{dyn}}} + \frac{F_z}{F_{z_{dyn}}} + \frac{M_x}{M_{x_{dyn}}} + \frac{M_y}{M_{y_{dyn}}} + \frac{M_z}{M_{z_{dyn}}} \leq 1$ table values						
No-load torque							
Trapezoidal thread	18 x 4	18 x 8	24 x 5	24 x 10	32 x 6	32 x 12	
(Nm)	0,6	0,9	0,6	0,9	0,9	1,1	
Ballscrew	16 x 5	16 x 10	25 x 5	20 x 20	32 x 5	32 x 10	
(Nm)	0,5	0,8	0,5	0,8	0,7	0,9	
Geometrical moments of inertia of aluminium profile							
I_x mm ⁴	6,6x10 ⁵		22,2x10 ⁵		63,8x10 ⁵		
I_y mm ⁴	38,6x10 ⁵		122,0x10 ⁵		335,0x10 ⁵		
Elastic modulus N/mm ²	70000		70000		70000		

Driving torque:

$$M_a = \frac{F \cdot P \cdot S_i}{2000 \cdot \pi \cdot \mu} + M_n$$

$$P_a = \frac{M_a \cdot n}{9550}$$

- F = force (N)
- P = thread pitch (mm)
- S_i = safety factor 1,2 ... 2
- M_n = no-load torque (Nm)
- n = rpm of screw (min⁻¹)
- M_a = driving torque (Nm)
- μ = screw efficiency
- P_a = motor power (KW)

Efficiency of lead screws:

All ballscrew	0,900
Tr 18x4	0,399
Tr 18x8	0,565
Tr 24x5	0,384
Tr 24x10	0,550
Tr 32x6	0,360
Tr 32x12	0,524

Deflection:

$$f = \frac{F \cdot L^3}{E \cdot I \cdot 192}$$

- f = deflection (mm)
- F = load (N)
- L = free length (mm)
- E = elastic modulus 70000 (N/mm²)
- I = second moment of area (mm⁴)

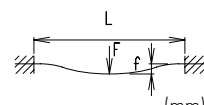

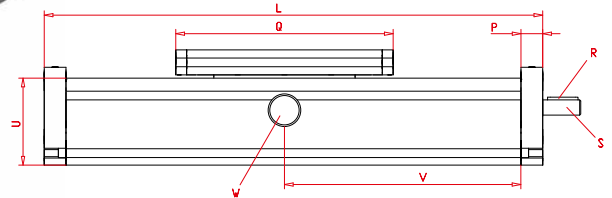
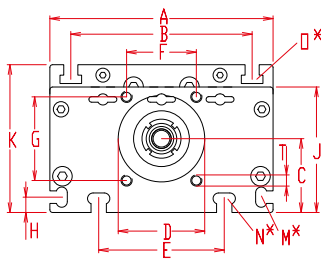

V = Q + 100 mm
W = servicing position

Increasing the carriage length will increase the basic length by the same amount.

Size	Basic length L	A	B	C	D +0,1 / +0,05	E	F	G	H	J	K	M for	N for	O for	P	Q	Shaft		T	U	Basic weight	Weight per 100 mm
																	R Key	S Ø h6 x length				
DL 120	200	120	96	39	47	78	42	42	10	68	79	M 5	M 6	M 6	15	156	3x3x25	10 x 27	M 6	60	3,9 kg	0,92 kg
DL 160	260	160	130	53	62	90	50	60	11	90	106	M 6	M 8	M 8	20	200	5x5x28	14 x 35	M 8	80	8,2 kg	1,96 kg
DL 200	320	200	160	66	68	140	60	60	15	110	129	M 8	M10	M10	20	270	6x6x40	22 x 45	M 8	100	19,6 kg	2,82 kg

T Spindle:
(T) Trapezoidal thread (K) Ballscrew

1 Selection of screw:
(1) right hand (2) left hand (Ballscrew by inquiry)

0 Choice of guide body profile: Stainless versions upon request.

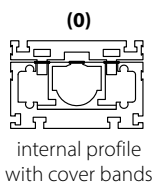

0 Choice of carriages:

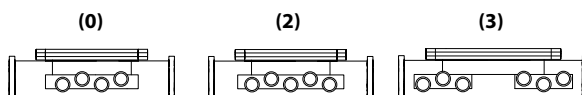

Size	Version 0		Version 2		Version 3	
	Q	L	Q	L	Q	L
120	156	200	196	240	>236	>280
160	200	260	250	310	>300	>360
200	270	320	330	380	>410	>460

0 Drive version:
(0) one shaft (locating bearing side) (1) one shaft (non-locating bearing side) (2) shaft on both sides

Selection of screw:	Size	Standard	Multistart screw				
Ballscrew right hand	120	(0) 16x5	(1) 16x10	(2) 16x16	(3) 20x20	(4) 25x5	(5) 25x10
	160	(0) 25x5	(1) 20x20	(2) 25x10	(3) 25x25		
	200	(0) 32x5	(1) 32x10	(2) 32x20	(3) 32x32		
Ballscrew left hand	upon request						
Trapezoidal right hand thread	120	(0) 18x4	(1) 18x8				
	160	(0) 24x5	(1) 24x10				
	200	(0) 32x6	(1) 32x12				
Trapezoidal left hand thread	120	(0) 18x4	(1) 18x8				
	160	(0) 24x5	(1) 24x10				
	200	(0) 32x6	(1) 32x12				

0 Ballscrew pitch accuracy:
(0) 0,05 mm / 300 mm (Standard) (2) 0,025 mm / 300 mm

0 End play of ball nut:
(0) 0,04 mm (Standard), (1) < 0,02 mm, (2) 2% apply prestress

Repeatability:
± 0,2 mm Trapezoidal
± 0,025 mm Ballscrew

DL T 160 1 0 0 0 0 0 0 1500 — Basic length + stroke = total length
Pos. 1 2 3 4 5 6 7

Sample ordering code:

DLT160, trapezoidal right hand thread, with internal profile and cover bands, standard carriage, one shaft (locating bearing side), spindle 24x5, 1240 mm stroke.

Linear system **DLT/DLK 120, 160, 200**

SPINDLE DRIVE, RIGHT-HAND / LEFT-HAND THREAD OR DIVIDED SPINDLES

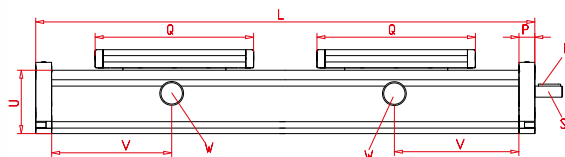
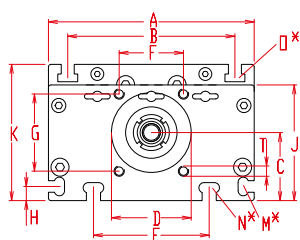

V = Q + 100 mm
W = servicing position

Increasing the carriage length will increase the basic length by the same amount.

Size	Basic length L	A	B	C	D +0,1 +0,05	E	F	G	H	J	K	M for	N for	O for	P	Q	Shaft		T	U	Basic weight	Weight per 100 mm
																	R Key	S Ø h6 x length				
DL 120	360	120	96	39	47	78	42	42	10	68	79	M 5	M 6	M 6	15	156	3x3x25	10 x 27	M 6	60	5,1 kg	0,92 kg
DL 160	470	160	130	53	62	90	50	60	11	90	106	M 6	M 8	M 8	20	200	5x5x28	14 x 35	M 8	80	12,0 kg	1,96 kg
DL 200	590	200	160	66	68	140	60	60	15	110	129	M 8	M10	M10	20	270	6x6x40	22 x 45	M 8	100	27,1 kg	2,82 kg

T Spindle:
(T) Trapezoidal thread (K) Ballscrew

3 Selection of screw:
(3) right - left hand (4) divided spindle

0 Choice of guide body profile: Stainless versions upon request.

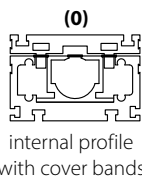

0 Choice of carriages:

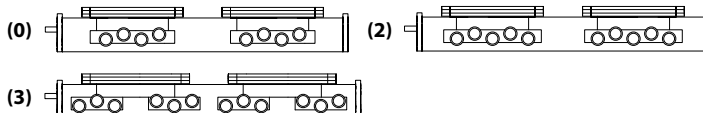

Size	Version 0		Version 2		Version 3	
	Q	L	Q	L	Q	L
120	156	360	196	440	>236	>530
160	200	470	250	570	>300	>670
200	270	600	330	720	>410	>880

0 Drive version:
(0) shaft right hand thread (1) shaft left hand thread (2) shaft on both sides

Selection of screw:	Size	Standard	Multistart screw
Ballscrew right hand	120	(0) 16x5	(1) 16x10* (2) 16x16* (3) 20x20* (4) 25x5* (5) 25x10*
	160	(0) 25x5	(1) 20x20* (2) 25x10* (3) 25x25*
	200	(0) 32x5	(1) 32x10* (2) 32x20* (3) 32x32*
Ballscrew left hand	upon request		
Trapezoidal right hand thread	120	(0) 18x4	(1) 18x8
	160	(0) 24x5	(1) 24x10
	200	(0) 32x6	(1) 32x12
Trapezoidal left hand thread	120	(0) 18x4	(1) 18x8
	160	(0) 24x5	(1) 24x10
	200	(0) 32x6	(1) 32x12

* = only for selection of divided spindle

0 Ballscrew pitch accuracy:
(0) 0,05 mm / 300 mm (Standard) (2) 0,025 mm / 300 mm

0 End play of ball nut:
(0) 0,04 mm (Standard), (1) < 0,02 mm, (2) 2% apply prestress

Repeatability:
± 0,2 mm Trapezoidal
± 0,025 mm Ballscrew

DL T 160 3 0 0 0 0 0 0 1500 — Basic length + stroke = total length
Pos. 1 2 3 4 5 6 7

Sample ordering code:

DLT160, trapezoidal right - left hand thread, with internal profile and cover bands, standard carriage, shaft on the right hand side, spindle 24x5, 1030 mm stroke